

T31 SERIES

Pump Manual

HORIZONTAL CLOSE COUPLED
FLEXIBLE COUPLED

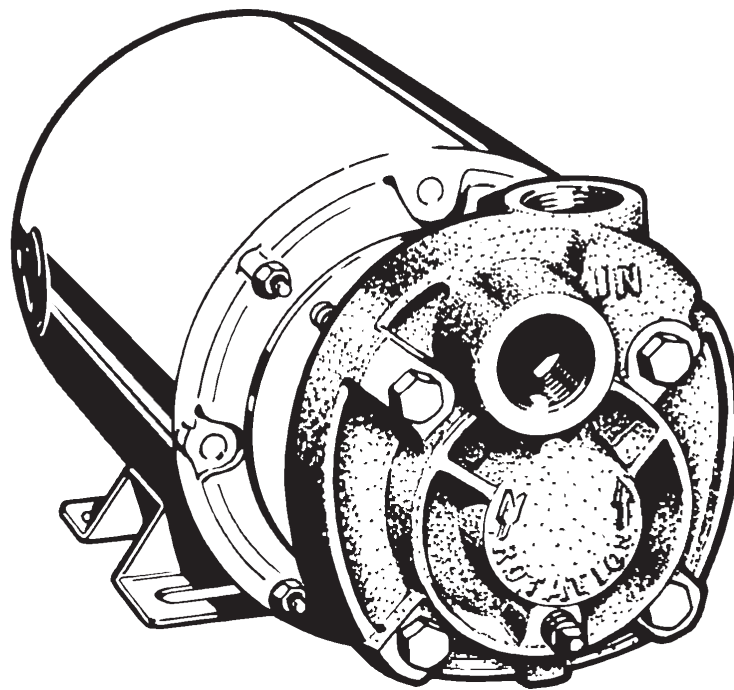

MTH PUMPS

401 West Main Street • Plano, IL 60545-1436
Phone: 630-552-4115 • Fax: 630-552-3688
Email: SALES@MTHPUMPS.COM
<http://WWW.MTHPUMPS.COM>

T31 SERIES

1. General Instructions

CLOSE COUPLED PUMPS FLEXIBLE COUPLED PUMPS

- A. Inspection of Equipment
- B. Storage
- C. Placing Stored Pumps Into Service
- D. Application Considerations
- E. Recommended Spare Parts

When properly installed and given reasonable care and maintenance, regenerative turbine pumps should operate satisfactorily for many years. Because of the high differential pressures expected in a regenerative turbine pump, close running clearances are used to reduce internal losses. Abrasive particles, even microscopic ones in high enough concentrations can open up the close clearances between internal cavities. For critical services it is recommended that you keep an identical pump for stand-by use.

1A Inspection of Equipment

Immediately upon receipt of the shipment, inspect the equipment for damage or missing components. Check the shipping manifest and report any damage or shortage to the Transportation Company's local agent. Inspect the crate and any wrapping material before discarding. Parts or accessories are sometimes wrapped individually or fastened to the skid.

Put the instructions that came with the shipment in a safe place where they will be available to those who will be using them for installation and service.

1B Storage

If the pump is to be stored before use, it should be inspected as described in 1A, re-crated and stored in a dry location. Standard shipping containers are not suitable for outdoor storage. In some areas, it may be necessary to cover the pump's exterior surface with oil or other rust inhibiting coating. All units are tested at the factory with a water/corrosion inhibitor solution, some of which will remain inside the pump upon receipt. If units are flushed out prior to storage, this inhibitor will be removed and proper care must be taken to prevent product deterioration from improper storage.

For storage beyond 30 days, a corrosion inhibiting protective fluid should be added to the internal pump cavities. Fluids used in the pump should be selected for compatibility with pump materials. This is very important when optional seal and gasket materials have been used. Protective caps on the inlet and outlets should also be used. Caps alone are not sufficient protection.

1C Placing Stored Pumps Into Service

Special care must be taken when placing stored pumps into service. First clean the outside and flush out the inside with a process compatible fluid. Try to turn the pump using the coupling or shaft. On close coupled units, access to the shaft is between the pump and motor. A vise grip

or other plier type gripping device may be used directly on the shaft. Applying torque to the motor fan blades is not recommended. If the impeller does not break loose immediately, fill the pump with a process compatible fluid and try again in a few hours.

If this fails, loosen only the pump cover thru bolts clamping the assembly together, one full turn, no more. Fill the pump with fluid. Apply torque, 50 foot pounds maximum, to the shaft. The pump should turn before 50 foot pounds is reached. If you are successful at breaking loose the unit, continue turning the pump while re-tightening the thru bolts to their original positions.

If the unit still won't turn over, DO NOT apply further force. Refer to the Disassembly/Reassembly Instructions in Section 5 to determine the cause of the problem.

1D Application Considerations

1D1 Electrical Wiring

All electrical equipment and wiring should conform to Local and National Electrical Codes. Use the motor manufacturer's instructions for connecting the motor. Note the correct rotation and wiring diagrams on the assembly. Make sure the motor rotation and speed matches that required for the pump. When making electrical connections to motors provided with threaded stud electrical terminals, the recommended torque should be 13-16 inch-lbs. Applying torque in excess of this range may cause damage.

1D2 Construction Materials

While it is reasonable to assume that good judgment has been used in selecting all the materials in the pump for compatibility with process fluids, actual conditions sometimes vary from original expectations. Also, typical material selection charts do not consider all the temperature, pressure, and fluid variables. The customer's engineer should be consulted for final judgment on the best materials for critical process applications.

1D3 Valves

The first valve to be considered for a regenerative turbine pumping system might be a pressure relief valve. Because this type of pump has a horsepower requirement similar to that of a positive displacement pump (constantly rising along with a pressure increase) a relief valve can be effectively used to limit horsepower. This is helpful when a non-overloading motor is specified. It can be of critical importance if the system flow rate can vary widely. There are almost no circumstances where a flow modulating valve will work successfully in a regenerative turbine pumping system. The steep pumping characteristic, typical of these pumps, produces very large pressure changes with small variations in flow rate. As a result, the modulating flow from the valve introduces sharp pressure shock

waves that shorten pump life and may cause damage in other pieces of equipment in the system.

If a shutoff valve is necessary in the suction line, use a gate, ball, butterfly, or other full port valve. Globe or other flow restricting valves can in some cases reduce pump flow or increase chances of cavitation.

A swing check valve is recommended in the suction line even when the pump inlet is only slightly higher than the fluid source. It should be the same size as the pump inlet or sized based on reasonable fluid friction losses.

A foot valve is recommended when lifting fluid from a sump. This will save wear and tear on any pump, even those equipped with self priming equipment.

A Y-Strainer is recommended immediately ahead of the pump on any newly constructed system. This is advisable due to the probability that foreign material large enough to damage pump clearances may remain even though the piping has been flushed.

Valves in the outlet piping of a regenerative turbine pump should always be open as far as possible when the pump is started. This will reduce the start-up load on the pump and motor. **Never start the pump with the discharge valve closed.**

Inlet valving should be open when starting any pumping system. Without some fluid in the pump, it can gall and lock up impellers. **Violent pump failure will result from continued operation with the inlet valve closed.**

1D4 Priming

Regardless of whether self-priming equipment is used or not, always fill the pump and vent it of air for best seal and pump life. Under most circumstances, regenerative turbine pumps can be made to self-prime as long as a small amount of fluid can be recirculated through the impeller and the fluid doesn't heat up noticeably.

1D5 NPSH (Net Positive Suction Head)

The NPSH required varies with every size and capacity of pump. The NPSH required by your unit can be obtained from the performance curves or from your MTH representative.

If the NPSH available is not equal to or greater than that required by the pump, it must be increased or a different pump selected. The usual method for increasing NPSH is to raise the static head on the pump inlet, (H_s).

By definition, NPSH means: "net positive suction head" above the vapor pressure of the pumped liquid available at the centerline of the pump. It should always be given in feet of pumped liquid. The NPSH is actually a measurement of the amount



WARNING:
CANCER AND REPRODUCTIVE HARM
WWW.P65WARNINGS.CA.GOV

of energy available in the pumped liquid to produce the required absolute entrance velocity in the pump. If a pump requires more energy (or NPSH) than is available at a given capacity, the pressure at the inlet will fall below the vapor pressure of the pumped liquid and loss of performance will result.

P_s = Pressure in the suction vessel in PSIA.

P_{vp} = Vapor pressure of the pumped fluid in PSIA.

H_s = Static height of the pumped fluid above (+) or below (-) the centerline of the pump.

H_f = All friction losses from the vessel to the pump.

$$NPSH = 2.31 \left(\frac{P_s - P_{vp}}{\text{sp. gr.}} \right) + H_s - H_f$$

For boiling liquids, P_s and P_{vp} are equal. This item then becomes zero and can be omitted from the equation.

1D6 Noise

Regenerative turbine pumps typically produce a high pitched whine that increases in intensity as the differential pressure produced in the pump increases. While high frequency sound is attenuated more easily than lower frequencies, piping structures and the fluids in them readily transmit noise. Motors, bearings, and other rotating components add to noise and sometimes create objectionable harmonics.

Careful pump installation can contribute to noise reduction. Proper alignment of the pump and driver is essential.

Adequate supports for the inlet and discharge piping is equally important. A degree of noise reduction may be obtained when the pumping unit is supported free of building structures by the use of vibration isolators, flexible piping and conduit connections. Elastomer type couplings are the best choice to separate motor noises from the fluid and piping structure.

1D7 Freezing

When ambient temperatures drop below the freezing point of the fluid in a pump, consideration should be given to heating, insulating, or draining the pump. If you choose draining the pump, and it will only be for a short period, first remove the drain plugs and drain the lines to and from the pump. Carefully blow out the pump with compressed air to clear all internal cavities of fluid.

1E Recommended Spare Parts

FOR CRITICAL SERVICES - a duplex installation, with two identical pumping units in parallel, is the safest and many times the most cost effective choice.

FOR IMPORTANT SERVICES - a stand-by pump, ready for installation is advised.

Special pricing and new pump warranty is offered for factory rebuilding. Turn around time can be as short as one or two days for standard models.

FOR ROUTINE MAINTENANCE - only the mechanical seals and a complete set of "O" ring gaskets are recommended. Should additional components show wear, they are available from stock at the factory.

FOR SERVICING A PUMP THAT DOES NOT PRODUCE RATED HEAD - mechanical seals, "O" ring gaskets, impeller, motor bracket, and cover.

FOR REBUILDING A PUMP - all the components required for servicing plus bearings, shaft, and drive keys for flexible coupled pumps, should be obtained. (A factory rebuild should be considered whenever your disassembly indicates rebuilding is necessary as this is usually more economical.)

The factory recommendation for spare parts are all of those needed for rebuilding a pump and are shown on the exploded view drawings for each individual type of pump.

T31 SERIES

2. Installation

CLOSE COUPLED PUMPS FLEXIBLE COUPLED PUMPS

- A. Location
- B. Foundation
- C. Leveling
- D. Alignment
- E. Piping

In order to insure that pumping equipment is installed properly and to obtain reliable pump operation, it is recommended that only experienced, qualified erecting engineers undertake this task. Read the instructions thoroughly before beginning.

2A Location

The first consideration for locating a pump is elevation. The lowest possible elevation using the shortest possible suction piping is usually the best. Questions regarding possible locations should be resolved by making inlet head calculations including all friction losses. The one producing the highest inlet pressure should be selected. One reason for this precaution is that, the greater the inlet pressure, the less likelihood of NPSH problems. Also a flooded suction is particularly helpful on start-up when the seals or the entire pump can be ruined because it is not properly primed and purged of air.

A dry, easily accessible location is also important. Allow ample clearance around the unit for free air circulation. If

a dry location is not available, the pump can be mounted on a foundation, above the floor. Specify motor enclosure, pump materials, or coatings to suit the worst conditions expected. Place the pump so that it can be easily inspected and serviced during operation. Sufficient head room should be provided, particularly when lifting devices will be used for heavier assemblies.

2B Foundation

Baseplates alone are not rigid enough to maintain alignment of the unit. The pump foundation is used as a support for the baseplate to maintain alignment of the unit. If the baseplate is to be grouted to the foundation, it is only necessary to embed the edges. It is unnecessary to completely fill under the baseplate. DO NOT grout the unit to the foundation until it has been properly aligned.

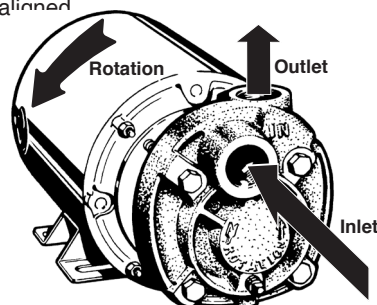

Figure 2-1

The foundation must be a permanent rigid installation of concrete or other material of sufficient mass to absorb all normal vibrations. Locate the foundation bolts using a layout or template in relation to the suction and discharge piping. If concrete is being used, foundation bolts of the specified size can be enclosed in a pipe sleeve two to three diameters larger than the bolts to compensate for minor variations in alignment.

Close coupled pumps can be mounted on a steel base prior to installation or mounted directly to the foundation. Place shims under one or more of the motor feet so that strain and distortion will not result when the mounting bolts are tightened.

2C Leveling (Flexible Coupled Pumps Only)

If the unit is received with the pump and motor mounted on the baseplate:

1. Place the unit in position.
2. Disconnect the coupling halves. Do not reconnect until all alignment procedures have been completed.
3. Support the baseplates on metal shims or wedges having a small taper. (Refer to Figure 2-2)
 - a. Place shims close to the founda-



WARNING:
CANCER AND REPRODUCTIVE HARM
WWW.P65WARNINGS.CA.GOV

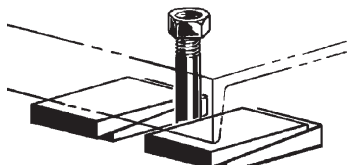

Figure 2-2

tion bolts. (Refer to Figure 2-2)

- b. Place shims close to where the greatest weight is located.
4. Check the baseplate for distortion:
 - a. Place a straightedge along the baseplate to determine if it is distorted.
 - b. Adjust the shims until the baseplate is not distorted.
5. Use a section of the pipe to determine if the inlet and discharge openings are vertical and located properly.
6. Correct the positions, if necessary, by adjusting the shims.

2D Alignment

Although flexible coupled pumps are carefully aligned prior to crating and shipping, it is almost a certainty that strains imposed during transit have altered the alignment. Complete the following steps after the unit has been placed on the foundation and leveled.

The standard coupling supplied by MTH Pumps has an elastomer member between two internal serrated flanges. They have smooth outsides of equal diameter. These surfaces are used for alignment procedures.

To check the PARALLEL alignment:

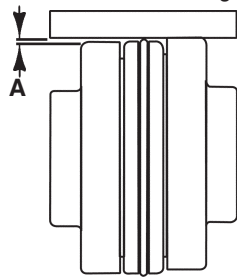

Figure 2-3

(Refer to Figure 2-3)

1. Place a straightedge across the two coupling flanges.
2. Measure the maximum offset (A), Figure 2-3, at various points around the periphery of the coupling. DO NOT rotate the coupling.
3. If the maximum offset exceeds .the Parallel dimension .015 inches, loosen the motor or pump and place thin metal shims under the motor or pump feet until the offset is set properly.
4. Torque down the motor or pump.
5. Recheck alignment.

The angular alignment dimension needs to be 0.070 or less.

1. Using a micrometer or caliper, measure

from the outside of one flange to the outside of the other at intervals around the periphery of the coupling. DO NOT rotate the coupling

2. Determine the maximum (B) and minimum (C) dimensions. Refer to Figure 2-4.

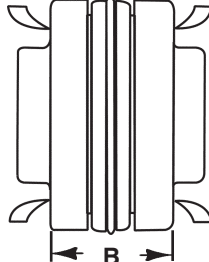

Figure 2-4

3. If the difference between the maximum and minimum exceeds the Angular dimension (0.070 inches), loosen the motor or pump and place thin metal shims under the motor or pump feet until the angular alignment is correct.
4. Torque down the motor or pump.
5. Recheck the parallel alignment above.

If the parallel (.015 inches) or angular (.070 inches) misalignment is great, this is an indication of baseplate distortion and must be corrected first, refer to 2C Leveling.

After all leveling and alignment operations have been completed, piping can begin. After the piping has been completed, refer to 2E1 Piping Alignment. Alignment of the unit must be checked again to make certain that no piping strains are causing distortion. After approximately two weeks of operation, check the alignment again to make sure that temperature changes, piping strain, or foundation variations have not caused misalignment. If alignment has been maintained over this period, the pump and motor can be doweled to the baseplate.

2E Piping

2E1 Piping Alignment

It is important that all piping be lined up and not forced into place. It is recommended that you begin piping at the pump. If the lines are ended at the pump, particularly if the last piece is cut a little too short or long, the pump will be forced to meet the pipe and strain or distortion will result.

2E2 Piping Support

Never allow the pump to support piping. Other means such as pipe hangers and pipe supports should be used to carry piping to avoid misalignment and distortion. Consideration should be given to thermally induced expansion and contraction, particularly in long runs of straight pipe.

2E3 Piping Size

In general, inlet and outlet pipe sizes should be equal to or larger than those of the pump.

This should not, however, be the determining factor. Many things including installation and operating costs are involved in the decision. Careful use of the pipe and fitting friction loss tables as shown in the Hydraulic Institute manual along with the appropriate pump performance curve should be the basis for judgments.

2F Typical Installation (Refer to Figure 2-5)

Figure 2-5 shows a typical pump installation, note the use of pipe hangers and support and the position of piping, valves, and components.

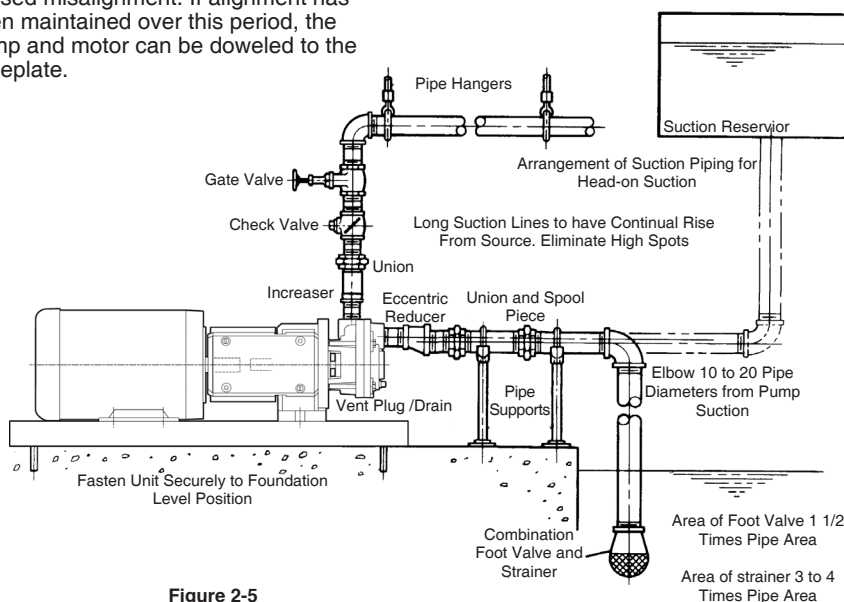

Figure 2-5



WARNING:
CANCER AND REPRODUCTIVE HARM
WWW.P65WARNINGS.CA.GOV

T31 SERIES

3. Operation

CLOSE COUPLED PUMPS FLEXIBLE COUPLED PUMPS

- A. Rotation
- B. Inlet and Outlet Locations
- C. Foreign Material
- D. Electrical
- E. Adjustments
- F. Cooling Water
- G. Priming
- H. Starting
- I. Stopping

3A Rotation

The standard direction of rotation of the pump is right handed, or clockwise when looking at the motor end of the pump. A rotation arrow, refer to Figure 3-1, is located on the pump to indicate the correct direction of rotation.

Operating the pump in reverse will cause substantial performance variations and can damage the pump.

Always confirm correct motor rotation prior to connection of the coupling. If this is not possible, or a final rotation check is being performed:

1. Jog the motor briefly.
2. Observe rotation as the unit comes to a stop.
3. Rotation should be in the direction of the arrow.

If the motor operates in the wrong direction:

1. Interchange any two leads on a three phase motor.
2. On a single phase motor, change the leads as indicated on the connection box cover. Some single phase motors may not be reversible.

3B Inlet and Outlet Locations (Refer to Figure 3-1)

The pump inlet is located on the end farthest from the motor. The discharge or "outlet" can be on the top, side, or bottom depending on the model and construction of the pump. Normal discharge position is on top.

3C Foreign Material

All regenerative turbine pumps have close running clearances in order to maintain efficiency. Take extra precautions to insure that no foreign material larger than 25 microns or .001 inches is allowed to pass through the pump. Even

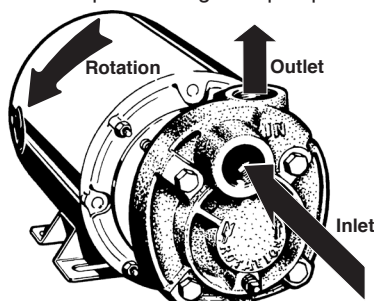

Figure 3-1

particles of this size can damage the pump if allowed to continue. Regenerative turbine pumps are not designed for slurries.

Large particles, weld spatter, and other material found in new piping systems will bend the impeller vanes and can sometimes lock up the pump. If a new pump does not operate properly, the first thing to check for is damage from foreign material.

3D Electrical

It is important to be aware of and follow the appropriate local and national electrical codes. Do not make wiring alterations that can affect motor rotation without reconfirming correct rotation. Select starter heaters and wiring for the maximum current the motor can use at full service factor loads. Regenerative turbine pumps will typically use extra power for a period until they run in. This can take three to four weeks depending on the duty cycle. During this period, impellers are finding their hydraulically balanced position.

3E Adjustments

No adjustments are required or advisable on new pumps. Because of the close fits in regenerative turbine pumps, it is not uncommon for the pump to be difficult to turn over by hand after they have been allowed to dry out inside. New pumps from the factory are tested using rust inhibitors to preclude this possibility. On site system flushing may remove these inhibitors and subject the pump to the risk of lock up, if it is allowed to dry out. In this case, do the following:

1. Fill the pump with fluid.
2. Loosen the thrubolts exactly one turn.
3. Jog the pump momentarily using the on/off buttons if so equipped.
4. This should "break" the impeller loose without damage, unless foreign material has entered the pump.
5. If possible, spin the pump (or operate with minimal or zero discharge pressure) while the thrubolts are retightened exactly one turn.

This will flush residue from the close fitting impeller surfaces.

Because of the large areas of close fitting surfaces inside these pumps, it takes only microscopic residue to produce resistance to rotation. Once loosened, this material is quickly dispersed and the impellers will find their hydraulic center. If these procedures have been followed, no damage will have resulted from "breaking loose" the impeller.

3F Cooling Water

When the pump is used to pump hot fluids, consideration should be given

to cooling the seals and/or selecting materials that will give satisfactory seal life. The actual temperature at the seal faces, the most critical area, will always exceed the surrounding fluid temperature. If seal flushing lines have not been installed, heat can build up in the seal faces to a degree that may destroy the fluid film necessary to prevent rapid wear. In some cases it is necessary to cool the seal flushing fluid. Refer to the seal manufacturers charts for guidance or to selection data in the MTH catalog anytime fluids can reach or exceed their boiling point.

3G Priming

Pumps should not be operated unless they are completely filled with liquid. Damage to parts of the pump that depend on liquid for their lubrication can occur. Impellers can seize quickly when a pump is run dry. Without lubrication, seal faces can be damaged from heat buildup.

Pumps can be easily primed with a vacuum pump. An ejector or liquid ring vacuum pump is recommended for this purpose because they are not damaged if liquid enters them.

Connect the vacuum line to the discharge side of the pump, either in the discharge opening or the drain tap. A foot valve is not necessary when this kind of device is used.

When a vacuum pump is not practical, a foot valve in the suction inlet can be used to prevent liquid from running out. The pump and suction line can then be filled completely from an outside source. A vent opening will be necessary during filling to let air escape. A tight foot valve will keep the pump constantly primed so that automatic operation is possible. The valve should be inspected regularly to see that it does not develop leaks which would allow the pump to run dry.

Optional self-priming casings are available for MTH pumps allowing priming when a vacuum pump or foot valve is not practical. Refer to specific literature for details.

There are four components to the self primer:

1. A check valve - necessary to maintain a vacuum in the suction line as surging occurs in the pump.
2. An air eliminator - used on the discharge side of the pump to separate air from liquid so the liquid can be used again as air is carried through the pump.
3. A recirculating line - carries liquid from the air eliminator to the suction.
4. A fluid chamber - used on the inlet side to provide a supply of fluid to speed up priming.



WARNING:
CANCER AND REPRODUCTIVE HARM
WWW.P65WARNINGS.CA.GOV

Small suction lines are desirable to minimize priming time.

Using the self priming casing, it is only necessary to:

1. Open the plugs in both the inlet and discharge chambers.
2. Pour fluid in one until both are full.
3. Tighten both plugs.
4. Turn on the pump.

Priming time depends on lift, volume of air in the suction line, and the size of the regenerative turbine pump used. If priming time is long and the pump becomes warm, refill the priming chambers with fresh liquid. Most turbine pumps will pump twenty-six to twenty-eight inches of mercury vacuum with cold water in the pump, but have very little capacity and therefore are not practical at lifts over twenty-two feet.

The best way to prime a pump and keep it primed is to use a flooded suction. While this is not always practical, it does provide a number of advantages. The likelihood of pump damage from dry running is eliminated. Suction lines may be large, reducing line losses and minimizing the potential of cavitation damage. There are no check valves or priming devices to fail or require maintenance. Whenever possible, design pumping systems with flooded suction.

3H Starting

Before starting a pump for the first time, be sure that all the preceding operations have been carried out. Proper rotation, priming, and a free turning pump are most important.

1. Start the pump with the minimum possible line restriction.
2. Open discharge valves before pressing the starter.
3. Start the pump and let the system clear of air.
4. Listen for foreign material being carried through the pump.
5. Slowly close necessary valves or otherwise place the pump into service.
6. Listen for indications of undue load or other sounds indicating problems.
7. Use a clip-on ammeter to check for a steady load after approximately fifteen minutes of operation.

3I Stopping

It is best to stop the pump with the least discharge head possible both for minimizing strain on components and to be in low power mode in anticipation of restarting. If the pump will be down for more than a few weeks it is advisable to drain it. Follow the instructions for long term storage, Section 1, 1B Storage. After any prolonged stoppage, turn the pump over by hand before restarting, to be sure it is free.

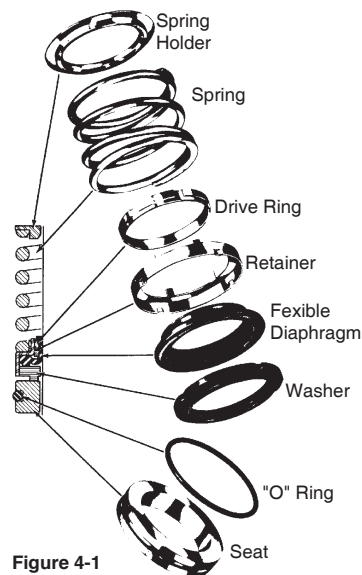

Figure 4-1

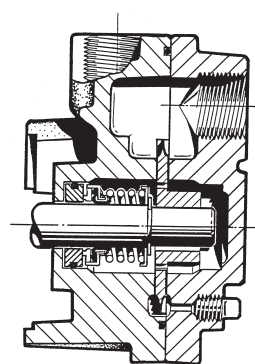

Figure 4-2 Standard Seal Construction

T31 SERIES

4. Maintenance

CLOSE COUPLED PUMPS

- A. Seals
- B. Cooling Water
- C. Lubrication

4A Seals

Mechanical seals are used in MTH Pumps to eliminate the maintenance that is normally associated with packing boxes. This does not, however, mean they can totally be ignored. Check a new installation for seal leakage.

Maintenance of seals consists primarily of periodic observation, looking for the first signs of failure. An occasional drip that continues to worsen is an indication that the seal has failed and must be replaced. Follow the appropriate disassembly/assembly instructions. Always shut down a pump with failed seals as soon as possible. Leaky seals are usually followed by bearing failures and then possible pump damage as rotating parts become mis-aligned.

4B Cooling Water

If a heat exchanger is used to supply cooling water for the seals, check the system periodically in the same way as 4B. As an additional system check, measure the temperature as it leaves the heat exchanger. This can be done with an external contact thermometer or by adding an appropriate fitting and internal thermometer. Cooling water should be kept below 200°F. External cooling water sources should be checked for temperature and pressure. Line pressure at the seal chamber fitting must exceed that in the seal chamber by at least 5 psi. Refer to the specific instruction sheets for further cooling system information.

4C Lubrication

Sealed ball bearings are standard in all MTH pumps. The maximum continuous operating temperature for bearings is 250°F. While it is not advisable to routinely disassemble sealed bearings, it is possible to remove the seals during disassembly and determine their condition. Use new bearings for reassembly. While the pump is in service, listen for unusual sounds or changes in bearing noise. A screwdriver held between the bearing housing and your ear while the pump is rotated by hand is sometimes helpful if there is too much ambient noise when the system is operating.



WARNING:
CANCER AND REPRODUCTIVE HARM
WWW.P65WARNINGS.CA.GOV

T31 SERIES

5. Service

PUMP ENDS

- A. Preliminary
- B. Disassembly
- C. Inspection of Components
- D. Reassembly
- E. Testing and Final Adjustments

5A Preliminary

Before attempting any service on the pump or motor, disconnect the electrical power to the pump motor. If the pump and motor are to be removed as a unit, note the wiring configuration. Use colored or numbered tape to mark the wire connections of the motor and power source, for reconnection. If the pump is being used to pump hot liquid, let the pump and liquid cool before starting disassembly.

1. Disconnect the inlet and outlet piping before unbolting the pump and motor. If the pipes are corroded, use penetrating oil on the threads to aid in removal.
2. Unbolt the motor from the base and remove the unit. All work on the unit should be performed on an elevated workbench whenever possible.

5B Disassembly

The following tools and equipment are needed for disassembly of T31 Series Pumps:

1. Soft plastic or wooden mallet.
2. Small ball peen hammer.
3. 10mm wrench or socket
4. Snap ring pliers.
5. Penetrating oil.
6. 11/16" wood dowel (Approx. 6" long.)
7. Thin blade screwdriver.
8. P-80 Emulsion Temporary Rubber Lubricant or similar glycol base lubricant. (DO NOT use petroleum products.)

To disassemble the pump:

Refer to Figure 5-2 for reference to the numbered parts in the procedures below.

1. Remove all liquid from the pump. Air blown through the pump will remove the water quickly.
2. Remove the four (4) M6-1 X 80mm bolts (#19) from the cover (#2).
3. Remove the cover. In some cases light tapping with a plastic or wooden mallet on the outside diameter of the cover may be required to loosen it

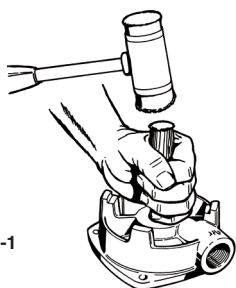

Figure 5-1

from the motor bracket. Care should be taken if a screwdriver is needed to pry between the cover and motor bracket. Damage to the "O" ring (#7) and/or impeller (#11) can result.

4. Remove the impeller. This is easily done by setting the motor on end. The impeller is a slip fit and under normal conditions, can be removed by hand or by gently tapping on the end of the shaft with a mallet. Striking the shaft too hard could damage the seat, rotating element, or the motor. After removing the impeller, the impeller key (#23) needs to be removed from the shaft keyway.
5. Remove the snap ring (#4) from the shaft; note the spring that is held in place by the snap ring. Remove the spring from the shaft.
6. To remove the rotating element (#12), gently slide the motor bracket (#1) forward on the shaft to move the rotating element high enough to be removed by hand. Using tools on the rotating element may damage the rotating element or the seat. Take precautions to keep the rotating element clean if it is to be reused.
7. Next remove the motor bracket.
8. To remove the seat (#125). Refer to Figure 5-1. Place the motor bracket face down on a clean flat surface. Look into the opening in the center of the motor bracket, and you will see a portion of the seat. Insert the 11/16" dowel and, very gently, tap the seat until it drops out. Care must be taken with the seat. It is often a brittle material and is prone to breakage. **It is recommended that a new replacement seat be installed during reassembly.**

5C Inspection of Components

Thoroughly clean all parts. All components should be examined for wear and corrosion. Replace any parts that show visible wear. If the pump was not producing sufficient pressure or capacity, the clearances between the rings and impeller probably exceed the maximum allowable clearance. At minimum the impeller should be replaced in this case. If the total side running clearance for an impeller exceeds .007", it is unlikely that pump performance will reach that of a new pump except at lower discharge pressures.

The "O" rings and other elastomeric components should be replaced if they have been deformed or cut.

If seal components must be reused, carefully inspect for microscopic cracks and nicks. Scratches that might be ignored elsewhere can produce leakage if they are on seal carbons and seat wearing surfaces.

Cleanliness is imperative when working with mechanical seals. Almost unnoticeable particles between seal faces can be, and often are, the cause of early seal failures.

Check the impeller; it is designed to float. It should move easily on the shaft. As long as it can be moved on the shaft by hand, it is loose enough. If the impeller can be rocked or wobbled, it is too loose and must be replaced.

Check the shaft for galling, pitting, and corrosion. If the shaft is corroded where the seal comes in contact with the shaft, the motor or bearing pedestal shaft must be replaced. Surface corrosion must be removed so that seals can slide freely during assembly. The shaft diameter should be no smaller than .002" below the nominal fractional seal sizes. Remove any nicks or burrs which may have occurred during disassembly. Re-clean parts as necessary.

5D Reassembly

All parts should be visually inspected and cleaned or replaced as outlined in 5C above.

1. The seal seat (#125) must be installed in the motor bracket (#1) before the bracket is installed on the motor. To install the seat:
 - a. Place the motor bracket face up on a flat surface.
 - b. Apply a coating of compatible lubricant to the elastomer portion of the seat to aid with installation.
 - c. Carefully press the seat, smooth side up, into the seat cavity of the motor bracket. Thumb pressure is usually sufficient to install the seat.
2. Install the motor bracket. This is best done with the motor standing on end. Make sure that both the "C"-face of the motor and the feet of the motor bracket are clean. Slide the motor bracket over the shaft onto the motor.
3. Install the rotating element (#12). Lubricate I.D. of the rotating element. Place the rotating element on the shaft with the carbon end towards the seat. Place the spring over the shaft, with the backing plate up and compress the spring to locate the rotating element against the seat. If this fails to seat the rotating element gently push the rotating element down with a thin blade screwdriver being careful not to damage the seat or the rotating element.
4. Compress and hold the seal spring slightly below the snap ring groove and install the snap ring (#4). Make sure the snap ring is locked in the groove.
5. Install the impeller key (#23) into the shaft keyway.



WARNING:
 CANCER AND REPRODUCTIVE HARM
 WWW.P65WARNINGS.CA.GOV

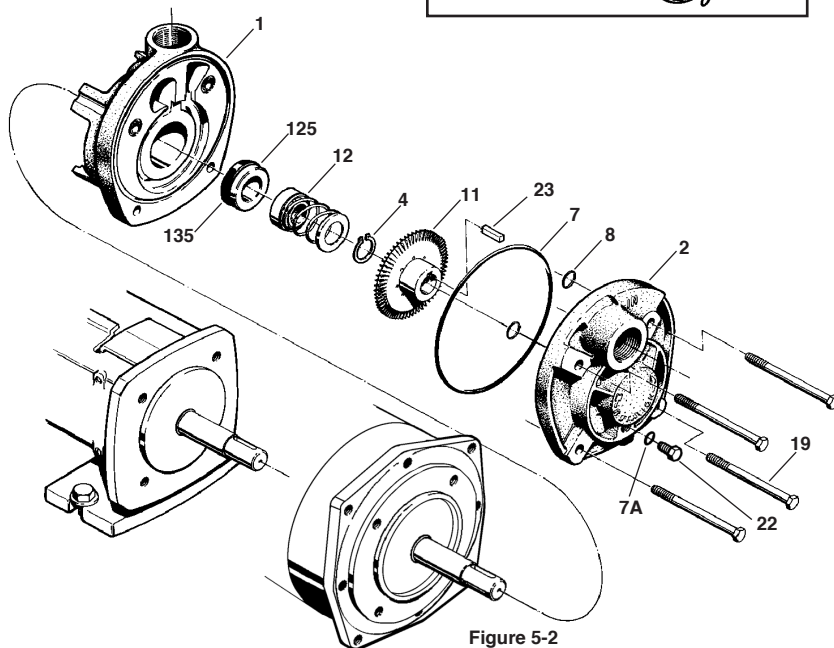
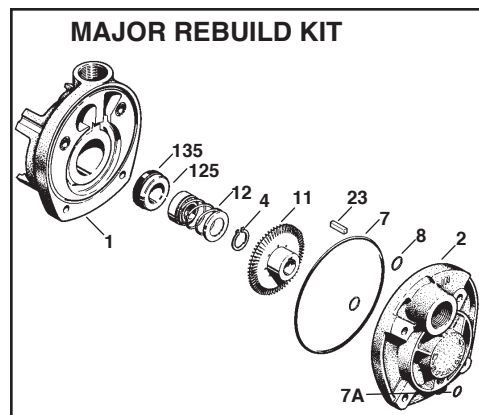
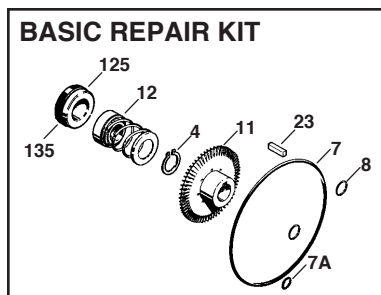
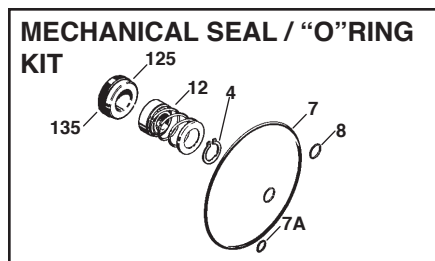

Figure 5-2

6. The impeller is a slip fit and should slide on firmly but easily until it stops against the impeller wearing surface. Force should not be required or used to install the impeller in the correct position. The impeller hub should be facing out away from the motor bracket. Refer to Figure 5-2.
7. Next, rotate the impeller by hand, the impeller should move freely.
8. Place the large "O" ring (#7) into the outside "O" ring groove in the motor bracket. Place the two (2) smaller "O" rings (#8) into the smaller "O" ring grooves.
9. Place the cover (#2) over the motor bracket and install the four (4) M6-1 X 80mm bolts (#19). Tighten the bolts systematically, alternating diagonally across the cover. DO NOT exceed 7-11 ft. lbs. of torque or damage to the motor "C"-face may occur.

5E Testing and Final Adjustment

The pump is now ready for installation. Final adjustments will be made with the pump in operation.

1. Connect all piping and fill the pump with fluid.
2. Reconnect the electrical connections, referring to the colored or numbered

tape used to mark the wires.

3. Make sure all valves are opened, and fluid will flow through the system.
4. Start the pump and make the final adjustments to the M6 bolts holding the cover on. These nuts and bolts must be torqued to about 7-11 ft. lbs. to obtain proper performance.
5. Check for leaks on pump and piping. Special attention should be given to the seal area at the rear opening in the motor bracket.
6. Under pressure, the impeller will find its "hydraulic" balance.
7. Using an amprobe or similar device, check for motor overload.
8. While the impeller is seating, it is common to experience some variance in readings. After a run-in period the readings should level off.

This completes the adjustment and testing phase. The pump is ready for service.

BEARING PEDESTALS

- A. Preliminary
- B. Disassembly
- C. Inspection of Components
- D. Reassembly
- E. Testing and Final Adjustments

T31 CLOSE COUPLED PUMP

NAME/DESCRIPTION	PART NO.	QTY.
Motor Bracket	1	1
Cover	2	1
"O" Ring/Casing	7	1
"O" Ring/Drain Plug	7A	1
"O" Ring/Thru Bolt	8	2
Snap Ring	4	1
Impeller	11	1
Seal Rotating Element	12	1
Seal Stationary Seat	125	1
"O" Ring/Seal Seat	135	1
Thru Bolt	19	4
Pipe Plug	22	1
Key/Impeller Drive	23	1

5A Preliminary P2

1. Disconnect the inlet and outlet piping before unbolting the pump. If the pipes are corroded, use penetrating oil on the threads to aid in removal.
2. Unbolt the pump from the base and remove. Disassembly instructions for the pump are found in Section 5, T31 PUMP ENDS. All work on the unit should be performed on an elevated workbench whenever possible.

The disassembly and reassembly procedures are broken into two sections covering the following units :

- 5B — Disassembly of the P2 Unit.
- 5D — Reassembly of the P2 Unit.

An exploded view of the unit, Figure 5-3 is provided for referencing the numbers in the following procedures, i.e. flinger (#21).

5B Disassembly

The following tools and equipment are needed for disassembly of the P2 unit:

Tools:

1. Soft plastic or wooden mallet.
2. Arbor press or vise.
3. 3/4" X 6" piece of water pipe.
4. Internal snap ring plier.
5. Penetrating oil.

When installing or removing bearings from the shaft, the use of an arbor press is strongly recommended.



WARNING:
CANCER AND REPRODUCTIVE HARM
WWW.P65WARNINGS.CA.GOV

To disassemble the pedestal:

Refer to Figure 5-3 for reference to the numbered parts in the procedures.

1. Remove the flinger (#21) located in the pump end of the bearing pedestal (#3).
2. Using a snap ring plier, remove snap ring (#4).
3. Open the jaws of the vice approximately 2-1/4".
4. Place the pedestal, pump side down, on the jaws. Refer to Figure 5-4.

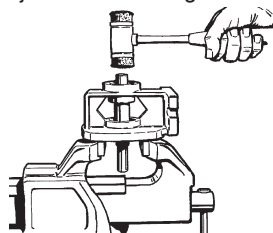

Figure 5-4

5. Using a plastic or wooden mallet, gently tap on the end of the shaft until it slides out of the frame. Both bearings should come out with the shaft. Do not use a metal hammer, severe damage to the shaft will occur.
6. Using the arbor press, remove the two (2) bearings from the shaft. Refer to Figure 5-5. If the inner race is well supported during this operation, no damage will be done to the bearings.

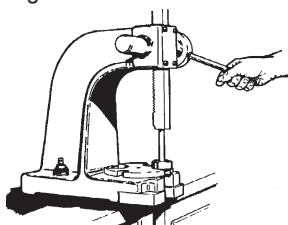

Figure 5-5

If an arbor press is not available, a bench vise may be substituted using the following instructions.

1. Remove the pedestal and close the jaws to approximately 1-1/8".
2. Place the shaft with either bearing resting on top of the jaws and gently tap on the end of the shaft until the bearing is removed. Refer to Figure 5-6.

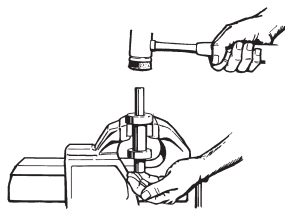

Figure 5-6

3. Repeat step 2 to remove the other bearing. Good support used on the inner races will prevent bearing damage.

5C Inspection of Components

Thoroughly clean all parts. All components should be examined for wear and corrosion. Replace any parts showing visible wear.

Check to be certain that a press fit still exists between the shaft and the bearings. New bearings, or at least cleaned and re-greased bearings, are recommended.

Check the shaft for galling, pitting, and corrosion. Surface corrosion on the pump portion of the shaft must be removed so the seals will slide freely during assembly. The shaft diameter should be no smaller than .002" below the nominal fractional seal sizes. Remove any nicks or burrs which may have occurred during disassembly. Re-clean parts as necessary.

5D Reassembly

All parts should be visually inspected and cleaned or replaced as outlined in 5C above. It is recommended that the bearings be replaced anytime the bearing pedestal is disassembled for service.

1. Using an arbor press, install the bearings on the shaft prior to installing the shaft into the pedestal. A steel "donut" with the proper inside diameter and outside diameter, Refer to Chart 1, should be used between the arbor face plate and the lower bearing to insure proper installation and to prevent bearing damage. The bearings must seat against the shoulder for proper alignment. Refer to Figure 5-7. *Also refer to Alternate bearing installation procedures.

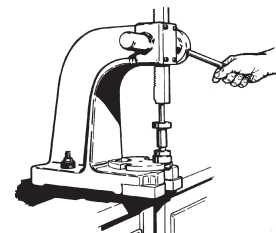

Figure 5-7

CHART 1	P2
Inside Diameter	1"
Outside Diameter	2"

2. Place the pedestal, pump mounting surface up, in a vise or suitable fixture and insert the bearing assembly. It should be possible to install the shaft assembly with firm thumb pressure. Refer to Figure 5-8. If more force is required, the butt end of a hammer handle or plastic mallet may be helpful. The shaft assembly should never be forced or driven in.
3. Install the snap ring (#4) in the pump end of the pedestal. Be sure the snap ring is seated properly in the groove. The beveled edge of the ring should face away from the bearing.
4. Install the flinger over the snap ring. The bearing pedestal is now ready for pump and motor installation.

***Alternate bearing installation procedures.**

If an arbor press is not available, the bearings may be installed on the shaft using the following procedure:

This procedure is not recommended and should only be used in an emergency situation.

1. Stand a piece of 3/4" pipe, with the threads cut off, on a workbench or similar flat surface, with the bearing placed on the correct shaft end.

P2 BEARING PEDESTAL

NAME/DESCRIPTION	PART NO.	QTY.
Bearing Pedestal	3	1
Snap Ring/ Bearing Retaining	4	1
Shaft	17	1
Flinger	21	1
Key Coupling	23	1
Ball Bearing/Inboard	24	1
Ball Bearing/Outboard	24A	1
Coupling Guard/Halves	30	2
Capscrew	33	4

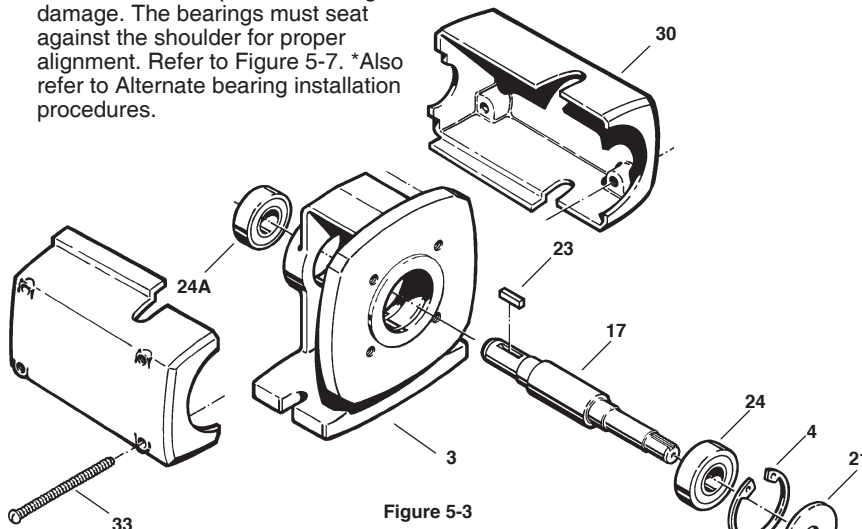

Figure 5-3



WARNING:
 CANCER AND REPRODUCTIVE HARM
 WWW.P65WARNINGS.CA.GOV

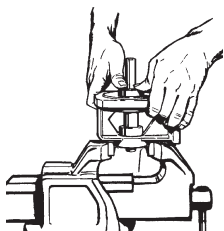

Figure 5-8

2. Insert the shaft into the pipe so the bearing is between the pipe and the shoulder of the shaft. Refer to Figure 5-9.
3. Using extreme caution, gently tap on the end of the shaft until the bearing rests against the shoulder. Never attempt to install the bearings by striking the outer race.
4. Repeat step 3 for the other bearing.

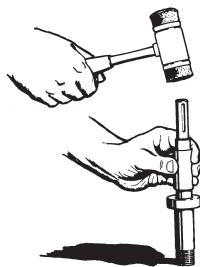

Figure 5-9

5E Testing and Final Adjustments

1. Check to be sure that the rotating assembly turns freely. Turn the shaft by hand. If it is tight or rough spots are encountered, it is likely that at least one of the bearings was damaged during disassembly/assembly operations and will have to be replaced.

2. Look to make sure that the lip seals on the bearings are positioned properly in their grooves. Correct if necessary. As the bearings are turned, the grooves should appear wet with oil but have no visible grease present.
3. Recheck the snap ring on the large bearing end. It should be firmly in place, and no axial motion should result from gentle tapping on either end of the shaft. (Use a soft mallet so shaft surfaces are not damaged.)
4. No adjustments are possible or required. Proceed with the appropriate pump end assembly operations. Refer to Section 5 SERVICE - PUMP ENDS (Final testing is done after the pump end is in place.)

T31 SERIES

6. Troubleshooting

CLOSE COUPLED PUMPS

- A. Failure to Pump
- B. Reduced Capacity
- C. Reduced Pressure
- D. Pump Loses Prime After Starting
- E. Excessive Power Consumption
- F. Pump Vibrates or is Noisy
- G. Mechanical Problems
- H. Seal Leakage

6A Failure to Pump

1. Pump not up to speed —
Use tachometer to determine actual RPM. Check voltage and wiring connections.
2. Pump not primed —
Confirm that pump and all inlet piping is filled with fluid.
3. Discharge head too high —
Install a pressure gauge at the pump discharge to determine the actual operating pressure. Compare readings with pump performance curve. A larger pump may be necessary.
4. Excessive suction lift —
Relocate pump, supply tank, or both to minimize suction lift.
5. Wrong direction of rotation—
Compare pump rotation with arrow on pump. Standard pumps rotate in a counterclockwise direction when looking at the shaft extension end. Clockwise from the motor end on close coupled pumps. Reverse two leads on a three phase motor to change rotation. Check motor nameplate for single phase operation.
6. Clogged suction line, strainer, or foot valve —
Inspect and clean out if necessary.
7. Air pocket in suction line —
Look for high spots in inlet piping system. Evacuate the system with a vacuum pump if necessary.

6B Reduced Capacity

1. Pump not up to speed —
Use a tachometer to determine actual RPM. Check voltage and wiring connections.
2. Excessive suction lift —
Relocate pump, supply tank, or both to minimize suction lift.
3. Insufficient NPSH —
Relocate pump, supply tank, or both to improve NPSH available if possible. Increase suction pressure. Reduce fluid temperature. Select a pump with lower NPSH requirements.
4. Mechanical damage —
Rotate the pump by hand to determine if there are tight spots. Broken or bent impeller vanes can sometimes be noticed in this manner. If there is suspicion of damage, remove the pump from service and disassemble for inspection.
5. Air leak in the suction line —
Fill the system with fluid and hydrostatically test. Tighten connections or replace leaky components.
6. Air pockets in the suction piping —
Operating the system at maximum flow conditions will usually clear the lines. Evacuate the system with a vacuum pump if necessary.
7. Suction lines, strainer, or foot valve too small or clogged —
Inspect and clean out as necessary. Fittings and lines should be at least equal to the pump suction size.
8. Discharge head too high —
Install a pressure gauge at the pump discharge to determine the actual operating pressure. Compare readings with pump performance curve. A larger pump may be necessary.
9. Excessive wear —
If a pump had previously performed

satisfactorily and now gives evidence of reduced performance, it should be disassembled and examined for wear after the simpler possible problems have been pursued.

6C Reduced Pressure

1. Pump not up to speed —
Use a tachometer to determine actual RPM. Check voltage and wiring connections.
2. Air or vapor in liquid —
Install a separator in the suction line. Hydrostatically test the system to insure that there are no leaks.
3. Mechanical wear or damage —
Rotate the pump by hand to determine if there are tight spots. Broken or bent impeller vanes can sometimes be noticed in this manner. If there is suspicion of damage or wear, remove the pump from service and disassemble for inspection. Look for wear on the impeller, suction cover, and motor bracket.
4. System head less than expected —
Replace pump with higher capacity unit or add a valve or orifice to increase line resistance.

6D Pump Loses Prime After Starting

1. Leak in suction line —
Fill the system with fluid and hydrostatically test. Tighten connections or replace leaky components.
2. Air entering pump through "O" rings —
Hydrostatically test the pump looking for leaks. Replace faulty "O" rings.
3. Insufficient NPSH or too much suction lift —
Relocate pump, supply tank, or both to improve inlet conditions. Increase suction pressure. Reduce fluid temperature. Select a pump with lower NPSH requirements.



WARNING:
CANCER AND REPRODUCTIVE HARM
WWW.P65WARNINGS.CA.GOV

6E Excessive Power Consumption

1. Speed too high —
Check RPM with tachometer.
2. Discharge head too high —
Install a pressure gauge at the discharge to determine the actual operating pressure. Compare readings with pump performance curve. A different pump, motor or both may be necessary.
3. Specific gravity or viscosity too high —
Check fluid involved. A different motor may be necessary.
4. Mechanical damage —
Turn pump over by hand. After a few days run in period, all models should turn over by hand with no tight spots. An exception to this is when the pump has been idle for some time. In this case, run the pump for a few hours before checking for tight spots. If there is suspicion of damage, remove the pump from service and disassemble for inspection.
5. Pump not fully broken in —
It is normal for new pumps to consume higher than normal current during the break-in period. If high power consumption persists beyond a few weeks, it is unlikely that further operation will reduce consumption.
6. Pump not properly adjusted —
Loosen all nuts on pump exactly one turn. Follow the instructions in Section 5E Testing and Final Adjustments for repositioning fasteners.

6F Pump Vibrates or Is Noisy

1. Insecure mounting —
Follow instructions in Section 2.
2. Piping load on pump —
Install piping supports and check to see that there is no strain on the pump.

3. Mechanical damage —
If mechanical damage is suspected, check first to determine if pump turns freely. Disassemble for inspection if tight spots are found.
4. Pump has a high pitched whine —
This is typical of a regenerative turbine pump. The intensity should increase as pressure increases. Over a period of a few weeks the noise level will diminish and will be noticeably quieter as it approaches a run-in condition.

6G Mechanical Problems

1. Short bearing life —
Bearings damaged due to leaky seals. Coupling misalignment. Piping load on pump. RPM or pressure too high.
2. Pump locked up —
Pump dried out and close clearances rusty. Follow installation instructions for loosening the pump. Foreign material in pump. Flush out. Disassemble if flushing is not successful.
3. Pump leaks —
Seal or "O" rings are usually the problem. Disassembly and replacement is the solution if tightening the through bolts has no effect.

6H Seal Leakage

1. Worn seat or rotating element —
Seals will last many years operating on cold clear water or other fluids with reasonable lubricity. Particles, even microscopic, increase normal wear rates. Temperatures near the fluid's boiling point can reduce lubricity which in turn increases wear. Some chemicals will erode the seal faces or plate out on the faces pro-

ducing an abrasive effect. Immediate seal replacement is recommended when leaks become evident, since bearings are quickly ruined as a result of moisture. Severe mechanical damage results when the bearings fail.

2. Improperly installed seat or rotating element —
If a seal has recently been replaced, look for a missing "O" ring around the seat, or a seat that is cocked or in backwards. The smooth surface should face the rotating element. The rotating element may be in backward or improperly positioned. Refer to the appropriate seal diagrams and instructions to confirm the correct seal orientation. Rotating elements sometimes stick in the wrong position if left partially assembled for some time. Make sure a rotating element can be moved axially on the shaft before closing up the pump and then make the final adjustments as soon as possible.
3. Seat broken during assembly—
Ceramic seats are particularly vulnerable to damage. Carefully follow reassembly instructions for seals.
4. Pitted shaft under the seal —
Reusing a shaft when repairing a pump is the probable cause of this problem. The seal rotating element can produce a pitted surface underneath its elastomer portion during normal use. This is normally not a problem for the first seal assembly since the elastomer is conforming as this action occurs. A new seal can leak before it conforms if the pits are large enough. If any pits are visible to the unaided eye, shaft replacement is advised.

T31 SERIES

7. Parts and Repair Services

- A. Parts
- B. Repair Service
- C. Warranty Service
- D. Motors, Mechanical Seals, and Accessories

7A Parts

Repair parts may be obtained through your local Authorized MTH Pumps Representative or Distributor who can be found in the yellow pages or by contacting MTH Pumps at 401 W. Main St. Plano, IL 60545
Phone: 630-552-4115
Fax: 630-552-3688.

7B Repair Services

Repair service for an MTH pump should be obtained from the company through which it was purchased.

In the event this is not possible, the name and phone number of a nearby MTH representative or distributor may be obtained by contacting MTH Pumps. In the event that it is necessary to return the pump to the factory for repairs, remove all accessories attached to the pump. We cannot accept responsibility for their safe removal, storage, and return.

7C Warranty Service

All requests for warranty claims should be made through the company from which the pump was purchased or supplied. Complete details on what is wrong with the pump must be provided along with information on the system in which it is installed. Refer to the MTH Pumps Limited Warranty statement. Return authorization must be obtained prior to returning any equipment.

7D Motors, Mechanical Seals, and Accessories

Repair or replacement service on motors, mechanical seals, relief valves, or other accessories should be obtained from the manufacturer of these components. MTH does not carry replacement parts and is not authorized to render repair service on these components. Replacement mechanical seals are stocked at MTH and are always available insofar as possible for immediate shipment. Warranty service, as well as expert application information can be obtained from your local seal manufacturer's sales office.



WARNING:
CANCER AND REPRODUCTIVE HARM
WWW.P65WARNINGS.CA.GOV

T31 SERIES

8. Limited Warranty

MTH makes good faith recommendations of Products, based on its experience and the application information provided by the Purchaser. However, the responsibility for testing and approving a Product to be used for a particular purpose lies with the Purchaser.

The obligations of MTH Tool Company, Inc. (hereinafter referred to as "MTH"), with respect to a "Product" (defined below) are limited as set forth herein.

ALL IMPLIED WARRANTIES, including the "implied warranty of merchantability" and the "implied warranty of fitness for a particular purpose" are HEREBY DISCLAIMED.

There are no warranties which extend beyond the description on the face hereof.

MTH warrants that, during the "Warranty Period" (defined below), the "Product" (defined below) will not fail to meet the "Operational Specifications" (defined below), within applicable industry tolerances established by the Hydraulic Institute, due to defects in its materials and workmanship. MTH does not warrant that any Product will meet the "Operational Specifications" in conditions other than the Standard Operating Conditions, unless agreed to by MTH in a signed writing.

For all purposes of this Limited Warranty:

- (a) The term "Warranty Period" shall mean the twelve (12) month period from the date of shipment from MTH to the Purchaser (the "Warranty Period").
- (b) The term "Product" shall mean: any item or assembly of items sold by MTH that are either manufactured or selected by MTH to meet the "Operational Specifications". The term "Product" does not include any item, assembly of items, or portion of such assembly that is selected or specified by any entity other than MTH, or that MTH has identified as ineligible for warranty coverage.
- (c) The term "Purchaser" shall mean the original person(s) or entity that issued the purchase order to MTH, for the Product.
- (d) The term "Operational Specifications" shall mean the specified dimensions, material composition, and performance parameters of a Product, as published by MTH, or as otherwise agreed in a signed writing between MTH and Purchaser. "Standard Operating Conditions", for pumps, shall mean: operating with clean water, at standard temperature and pressure. "Operational Specifications" shall not include visual appearance or any other parameters not expressly agreed to in writing.

If, within the Warranty Period, a Purchaser believes that a Product has failed to meet its Operational Specifications, the Purchaser must request a Return Goods Authorization ("RGA") in the manner specified at <http://www.mthpumps.com>, and supply any additional information MTH might reasonably request. If the Product was purchased through a distributor or any entity other than MTH, the RGA request must be made through that entity. Any Product returned without an RGA will be refused at the dock. Products authorized for return must be properly packaged to prevent further damage, clearly marked with the Return Goods Authorization "RGA" number provided by MTH, and shipped freight prepaid and allowed, F.O.B. the MTH factory at Plano, Illinois, USA.

MTH may, in its sole discretion, deny any warranty claim if shipping damage, any attempted disassembly, or any other action outside of MTH's control impairs MTH's determination of the existence of, or cause of a claimed failure.

Notwithstanding anything to the contrary in this Limited Warranty, MTH **shall have no obligation** to repair or replace any Product it determines to have any defects arising from or attributable to: (1) abrasion, corrosion, or erosion arising after shipment from MTH; (2) improper handling, packaging, installation, storage, or maintenance, after it is shipped by MTH; (3) repairs or alterations outside of MTH's factory, in any manner, without MTH's written authorization; (4) misuse, negligence, or accident after shipment from MTH; (5) use in a manner inconsistent with MTH's published instructions and Operational Specifications, or other written specifications agreed to by both Purchaser and MTH; or (6) incorrect power supply or power quality. MTH's determination with respect to the applicability of this Limited Warranty to any particular defect or Product shall be final and conclusive.

If, after examination by an authorized representative of MTH, MTH determines that the Product failed to meet the "Operational Specifications", within applicable industry tolerances established by the Hydraulic Institute, due to defects in its materials and workmanship, during the Warranty Period, then MTH will, at its option, ship a repaired or replaced Product to the Purchaser, F.O.B. MTH's factory in Plano, Illinois, U.S.A., freight prepaid and allowed. MTH will use a freight provider of its choosing, via a method no faster than that used for shipping the Product to MTH. MTH may, at its sole discretion, issue a credit memo to Purchaser for some or all Purchaser's shipping costs to return a defective Product to MTH.

MTH accepts no responsibility for costs associated with removal and reinstallation of Products.
Under no circumstances shall MTH be liable for incidental or consequential damages.

MTH neither assumes responsibility for, nor authorizes any person to assume for it, any other obligation in connection with the sale of any Product or any enlargement of this Limited Warranty.

Some States do not allow the exclusion or limitation of incidental or consequential damages. So, the above limitations or exclusions might not apply to you. This warranty gives you specific legal rights, and you might, also, have other rights, which vary from State to State.

By using this Product, you agree that this Limited Warranty is governed by the laws of the State of Illinois; that this Limited Warranty shall be interpreted and enforced only in accordance with the laws of the State of Illinois (excluding its conflicts of law provisions); and that you submit yourself to the jurisdiction of the 23rd Judicial Circuit, Kendall County, Illinois, which shall have exclusive jurisdiction over any controversy or dispute arising under or with regard to this Limited Warranty.



Download a digital copy of the manual here.



MTH PUMPS

401 West Main Street • Plano, IL 60545-1436
Phone: 630-552-4115 • Fax: 630-552-3688
Email: SALES@MTHPUMPS.COM
<http://WWW.MTHPUMPS.COM>



Find curves, dimensions, & other product information.



WARNING:
CANCER AND REPRODUCTIVE HARM
WWW.P65WARNINGS.CA.GOV